

# 9,000 Series bioCycle Wastewater Treatment System Pump Discharge

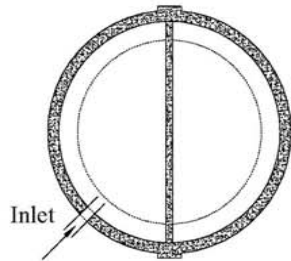

Tank Plan

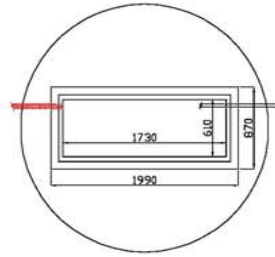

Lid Plan

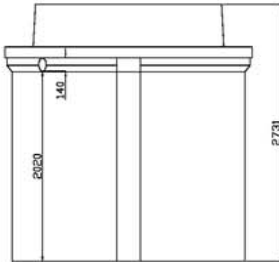

Inlet Elevation

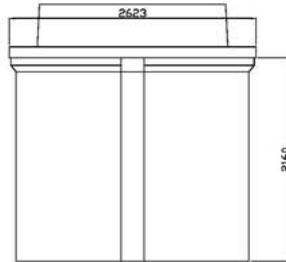

Side Elevation

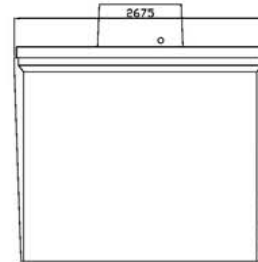

Outlet Elevation

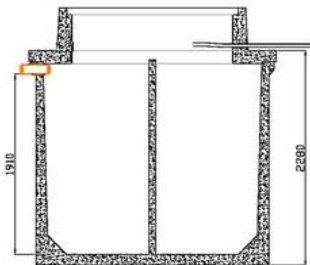
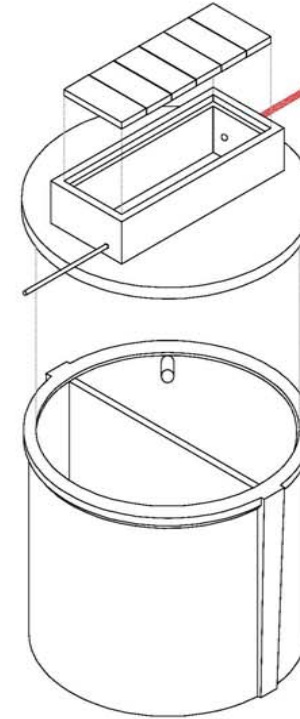

Cross Section



Lid Section

Excavation to be ( 3.2m) x ( 3.2m) x(3m) deep

Itemref	Quantity	Title/Name, designation, material, dimension etc			Article No /Reference	
Designed by Biocycle Ltd	Checked By	Approved by	Date	File name	Date	Scale 1:50@A3
				Cross Section through bioCycle		
				<b>9000 Series bioCycle System</b>		Edition 0